

 FULL LIFT SAFETY VALVE zARMAK



Body material	Nominal pressure	Nominal diameter	Max. temperature	Ex. index
B Nodular cast iron	C 16 bar	DN 20-32	200°C	775-I











CE 1433

FEATURES

- valves made according to PN EN ISO 4126-1
- high tightness

APPLICATION *

* not all of the applications are suitable for all of the executions

industries					
	INDUSTRY	SHIPBUILDING INDUSTRY	HEATING	REFRIGERATION AND AIR CONDITIONING	POWER ENGINEERING
media					
	GLYCOL	INDUSTRIAL WATER	STEAM	COMPRESSED AIR	NEUTRAL FLUIDS

Data given can be changed without notice.

Edition 01/2018

MATERIALS, DIMENSIONS

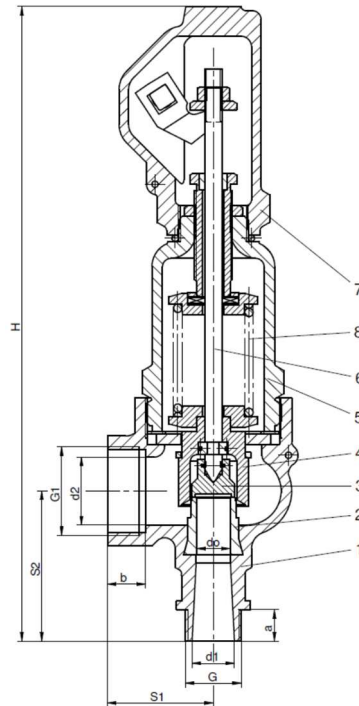

	Body material	B
	Type	standard
		01-1, 02-1, 03-1, 04-1, 05-1, 06-1, 07-1, 08-1
1	Body	EN-GJMW-400-5 / EN-GJS-400-15 5.3106
2	Seat	X39CrMo17-1 1.4122
3	Disc	X39CrMo17-1 1.4122
4	Bell	X20Cr13* 1.4021
5	Bonnet	EN-GJS-400-15 5.3106
6	Spindle	X20Cr13* 1.4021
7	Lifting cap	EN-GJS-400-15 5.3106
8	Spring	51CrV4 1.8159
Temperature range		-10...200°C**

* for marine type (05, 06, 07, 08) spindle and bell made of: X17CrNi16-2

** for steam boilers are limits according to WUDT-UC-WO-M, i.e. 10 bar and 200°C

Data given can be changed without notice.

Edition 01/2018

ZETKAMA Sp. z o.o.
Ul. 3 Maja 12
PL 57-410 Ścinawka Średnia

Tel. +48 74 8652 193
Tel. +48 74 8652 111
Fax +48 74 8652 199

E-mail export@zetskama.com.pl
www.zetskama.com

Body material		Type	T		
DN			20x32	25x40	32x50
d _o (mm)			16	20	25
A (mm ²)			201	314	491
a (mm)			15	18	19
G ₁ (cal)			¾	1	1¼
b (mm)			18	20	22
G ₂ (cal)			1¼	1½	2
S ₁ (mm)			50	54	65
S ₂ (mm)			71	80	88
H (mm)			298	328	357
Pressure at the beginning of the opening (bar)	min		1,5		
	max		16*		
Weight (kg)		3,4	4,1	5,4	

* for steam boilers are limits according to WUDT-UC-WO-M, i.e. 10 bar and 200°C

DISCHARGE COEFFICIENTS

Media	Ranges	DN		
		20x32	25x40	32x50
S/G	b ₁ = 10% for 1,5 ≤ p < 4 bar	0,60	0,63	0,66
	b ₁ = 10% for 4 ≤ p ≤ 16 bar	0,66	0,68	0,72
L	b ₁ = 10%	0,26	0,29	0,36
S/G type with limited disc leap	b ₁ = 10% for 1,5 ≤ p < 4 bar	0,30	0,36	0,48
	b ₁ = 10% for 4 ≤ p ≤ 16 bar	0,33		0,52

PRESSURE-TEMPERATURE RATINGS

	PN		140°C	RT	50 °C	100 °C	150 °C	200 °C
EN-GJS-400-15	16	bar	16	16	16	16	15,5	14,7

Data given can be changed without notice.

Edition 01/2018

CAPACITY TABLE FOR AIR

Standard type: 01-1, 02-1, 05-1, 07-1							
DNxDN PN16	20x32	25x40	32x50	DNxDN PN16	20x32	25x40	32x50
A - flight computational area [mm ²]	201	314	491	A - flight computational area [mm ²]	201	314	491
Pressure at the beginning of bar opening (g)	Air 20°C [kg/h]			Pressure at the beginning of bar opening (g)	Air 20°C [kg/h]		
1,50	272	446	730	6,50	919	1 479	2 449
1,60	283	464	760	7,00	981	1 579	2 614
1,70	294	483	790	7,50	1 043	1 679	2 779
1,80	305	501	821	8,00	1 105	1 778	2 944
1,90	317	520	851	8,50	1 167	1 878	3 110
2,00	328	538	881	9,00	1 229	1 978	3 275
2,10	339	556	912	9,50	1 291	2 078	3 440
2,20	351	575	942	10,00	1 353	2 178	3 605
2,30	362	593	972	10,50	1 415	2 277	3 771
2,40	373	612	1 003	11,00	1 477	2 377	3 936
2,50	384	630	1 033	11,50	1 539	2 477	4 101
2,60	396	649	1 063	12,00	1 601	2 577	4 266
2,80	418	686	1 124	12,50	1 663	2 677	4 432
3,00	441	723	1 184	13,00	1 725	2 776	4 597
3,20	463	760	1 245	14,00	1 849	2 976	4 927
3,40	486	797	1 305	15,00	1 973	3 176	5 258
3,60	508	834	1 366	16,00	2 097	3 375	5 588
3,80	531	871	1 427				
4,00	609	980	1 622				
4,20	634	1 020	1 689				
4,40	658	1 060	1 755				
4,60	683	1 100	1 821				
4,80	708	1 140	1 887				
5,00	733	1 180	1 953				
5,50	795	1 279	2 118				
6,00	857	1 379	2 283				

Capacity calculated at overpressure $b_1 = 0,1$ bar or $b_1 = 10\%$

Data given can be changed without notice.

Edition 01/2018

ZETKAMA Sp. z o.o.
Ul. 3 Maja 12
PL 57-410 Ścinawka Średnia

Tel. +48 74 8652 193
Tel. +48 74 8652 111
Fax +48 74 8652 199

E-mail export@zetkama.com.pl
www.zetkama.com

CAPACITY TABLE FOR AIR

Standard type: 03-1, 04-1, 06-1, 08-1							
DNxDN PN16	20x32	25x40	32x50	DNxDN PN16	20x32	25x40	32x50
A - flight computational area [mm ²]	201	314	491	A - flight computational area [mm ²]	201	314	491
Pressure at the beginning of bar opening (g)	Air 20°C [kg/h]			Pressure at the beginning of bar opening (g)	Air 20°C [kg/h]		
1,50	136	255	531	6,50	459	783	1 769
1,60	141	265	553	7,00	490	836	1 888
1,70	147	276	575	7,50	521	889	2 007
1,80	153	286	597	8,00	552	942	2 127
1,90	158	297	619	8,50	583	994	2 246
2,00	164	307	641	9,00	614	1 047	2 365
2,10	170	318	663	9,50	645	1 100	2 485
2,20	175	329	685	10,00	676	1 153	2 604
2,30	181	339	707	10,50	707	1 206	2 723
2,40	187	350	729	11,00	738	1 259	2 843
2,50	192	360	751	11,50	769	1 311	2 962
2,60	198	371	773	12,00	800	1 364	3 081
2,80	209	392	817	12,50	832	1 417	3 201
3,00	220	413	861	13,00	863	1 470	3 320
3,20	232	434	905	14,00	925	1 576	3 559
3,40	243	455	949	15,00	987	1 681	3 797
3,60	254	477	993	16,00	1 049	1 787	4 036
3,80	265	498	1 038				
4,00	304	519	1 172				
4,20	317	540	1 220				
4,40	329	561	1 267				
4,60	342	582	1 315				
4,80	354	603	1 363				
5,00	366	624	1 410				
5,50	397	677	1 530				
6,00	428	730	1 649				

Capacity calculated at overpressure $b_1 = 0,1$ bar or $b_1 = 10\%$

Data given can be changed without notice.

Edition 01/2018

CAPACITY TABLE FOR SATURATED STEAM

Standard type: 01-1, 02-1, 05-1, 07-1							
DNxDN PN16	20x32	25x40	32x50	DNxDN PN16	20x32	25x40	32x50
A - flight computational area [mm ²]	201	314	491	A - flight computational area [mm ²]	201	314	491
Pressure at the beginning of bar opening (g)	Saturated steam [kg/h]			Pressure at the beginning of bar opening (g)	Saturated steam [kg/h]		
1,50	170	278	456	6,50	565	909	1 505
1,60	177	290	476	7,00	601	968	1 603
1,70	185	303	497	7,50	639	1 028	1 702
1,80	193	317	519	8,00	676	1 087	1 800
1,90	200	327	536	8,50	712	1 147	1 898
2,00	206	338	553	9,00	750	1 207	1 998
2,10	212	348	571	9,50	786	1 266	2 095
2,20	219	359	588	10,00	824	1 326	2 195
2,30	226	370	607	10,50	860	1 384	2 292
2,40	233	382	625	11,00	897	1 444	2 391
2,50	240	394	645	11,50	934	1 503	2 488
2,60	247	406	665	12,00	971	1 562	2 586
2,80	262	429	703	12,50	1 007	1 621	2 684
3,00	275	451	738	13,00	1 044	1 680	2 782
3,20	288	472	774	14,00	1 118	1 799	2 978
3,40	302	495	812	15,00	1 191	1 917	3 174
3,60	317	520	851	16,00	1 264	2 035	3 369
3,80	330	541	887				
4,00	377	608	1 006				
4,20	392	632	1 046				
4,40	408	657	1 087				
4,60	424	682	1 129				
4,80	438	705	1 167				
5,00	452	728	1 206				
5,50	491	790	1 308				
6,00	527	848	1 404				

Capacity calculated at overpressure $b_1 = 0,1$ bar or $b_1 = 10\%$

Data given can be changed without notice.

Edition 01/2018

ZETKAMA Sp. z o.o.
Ul. 3 Maja 12
PL 57-410 Ścinawka Średnia

Tel. +48 74 8652 193
Tel. +48 74 8652 111
Fax +48 74 8652 199

E-mail export@zetkama.com.pl
www.zetkama.com

CAPACITY TABLE FOR SATURATED STEAM

Standard type: 03-1, 04-1, 06-1, 08-1							
DNxDN PN16	20x32	25x40	32x50	DNxDN PN16	20x32	25x40	32x50
A - flight computational area [mm ²]	201	314	491	A - flight computational area [mm ²]	201	314	491
Pressure at the beginning of bar opening (g)	Saturated steam [kg/h]			Pressure at the beginning of bar opening (g)	Saturated steam [kg/h]		
1,50	85	159	331	6,50	282	481	1 087
1,60	89	166	346	7,00	301	512	1 157
1,70	92	173	361	7,50	319	544	1 229
1,80	97	181	377	8,00	338	576	1 300
1,90	100	187	390	8,50	356	607	1 371
2,00	103	193	402	9,00	375	639	1 443
2,10	106	199	415	9,50	393	670	1 513
2,20	109	205	428	10,00	412	702	1 586
2,30	113	212	441	10,50	430	733	1 655
2,40	116	218	455	11,00	449	765	1 727
2,50	120	225	469	11,50	467	796	1 797
2,60	124	232	483	12,00	485	827	1 868
2,80	131	245	512	12,50	504	858	1 938
3,00	137	257	537	13,00	522	889	2 009
3,20	144	270	563	14,00	559	952	2 151
3,40	151	283	590	15,00	596	1 015	2 292
3,60	158	297	619	16,00	632	1 077	2 433
3,80	165	309	645				
4,00	189	322	727				
4,20	196	334	755				
4,40	204	348	785				
4,60	212	361	815				
4,80	219	373	843				
5,00	226	386	871				
5,50	245	418	944				
6,00	264	449	1 014				

Capacity calculated at overpressure $b_1 = 0,1$ bar or $b_1 = 10\%$

Data given can be changed without notice.

Edition 01/2018

CAPACITY TABLE FOR WATER

Standard type: 03-1, 04-1, 06-1, 08-1							
DNxDN PN16	20x32	25x40	32x50	DNxDN PN16	20x32	25x40	32x50
A - flight computational area [mm ²]	201	314	491	A - flight computational area [mm ²]	201	314	491
Pressure at the beginning of bar opening (g)	Water 20°C [kg/h]			Pressure at the beginning of bar opening (g)	Water 20°C [kg/h]		
1,50	3 401	5 949	11 548	6,50	7 107	12 384	24 040
1,60	3 513	6 144	11 927	7,00	7 376	12 852	24 947
1,70	3 621	6 333	12 294	7,50	7 635	13 303	25 823
1,80	3 740	6 517	12 651	8,00	7 885	13 739	26 670
1,90	3 843	6 696	12 997	8,50	8 128	14 162	27 490
2,00	3 943	6 870	13 335	9,00	8 363	14 573	28 287
2,10	4 040	7 039	13 664	9,50	8 592	14 972	29 063
2,20	4 135	7 205	13 986	10,00	8 816	15 361	29 818
2,30	4 228	7 367	14 300	10,50	9 033	15 740	30 554
2,40	4 319	7 525	14 608	11,00	9 246	16 111	31 273
2,50	4 408	7 680	14 909	11,50	9 454	16 473	31 976
2,60	4 495	7 833	15 204	12,00	9 657	16 827	32 663
2,80	4 665	8 128	15 778	12,50	9 856	17 174	33 337
3,00	4 829	8 413	16 332	13,00	10 051	17 514	33 997
3,20	4 987	8 689	16 867	14,00	10 431	18 175	35 281
3,40	5 140	8 957	17 386	15,00	10 797	18 813	36 519
3,60	5 289	9 217	17 891	16,00	11 151	19 430	37 717
3,80	5 434	9 469	18 381				
4,00	5 576	9 715	18 858				
4,20	5 713	9 955	19 324				
4,40	5 848	10 189	19 779				
4,60	5 979	10 418	20 223				
4,80	6 108	10 642	20 658				
5,00	6 234	10 862	21 084				
5,50	6 538	11 392	22 113				
6,00	6 829	11 898	23 097				

Capacity calculated at overpressure $b_1 = 0,1$ bar or $b_1 = 10\%$

Data given can be changed without notice.

Edition 01/2018

ZETKAMA Sp. z o.o.
Ul. 3 Maja 12
PL 57-410 Ścinawka Średnia

Tel. +48 74 8652 193
Tel. +48 74 8652 111
Fax +48 74 8652 199

E-mail export@zetkama.com.pl
www.zetkama.com

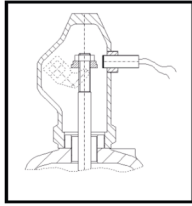
OPTIONS

Type with inductive sensor with operation alert

Operation range:
 depending on the type and diameter of the valve
Supply voltage:
 10 ÷ 30 V [DC]
Degree of protection:
 IP67, IP68 (depending on sensor type)
Operating temperature:
 -25 ÷ 70°C
 Other upon agreement with the manufacturer
Standard cable length
 2000 mm

ATEX 
The product meets the requirements of the following standards

PN-EN 1127:1:2011

PN-EN 13463-1:2011

PN-EN 13463-1:2010

The product is labelled:

II 2G c IIC TX
ATTENTION

- In the case of when condensate forms, provide drainage in the lowest spot of blow-out installation. Drainage in the body valve is made only upon request of the customer. For liquids, blow-out installation should be made in a tilted way.
- Valves should be mounted in a vertical position.

Data given can be changed without notice.

Edition 01/2018

TYPES

Figure	Body material	Nominal diameter	Nominal pressure	Type
775	B Nodular cast iron EN-GJS-400-15	20-32 mm	C 16 bar	01-1 normal type for gases and vapours; sealing metal/metal
				02-1 gas tight type for gases and vapours; sealing metal/metal
				03-1 type with limited disc leap for liquids; sealing metal/metal
				04-1 type with limited disc leap for liquids, gases and vapours, sealing metal/metal
				05-1 marine type for gases and vapours, sealing metal/metal
				06-1 marine type with limited disc leap for liquids, gases and vapours, sealing metal/metal
				07-1 marine type, gas-tight for gases and vapours, sealing metal/metal
				08-1 marine type, gas-tight with limited disc leap for liquids, gases and vapours sealing metal/metal

ORDERING

Figure	Body material	Nominal diameter	Nominal pressure	Type
775	B Nodular cast iron EN-GJS-400-15	20-32 mm	C 16 bar	01-1 normal type for gases and vapours; sealing metal/metal

Order example by index

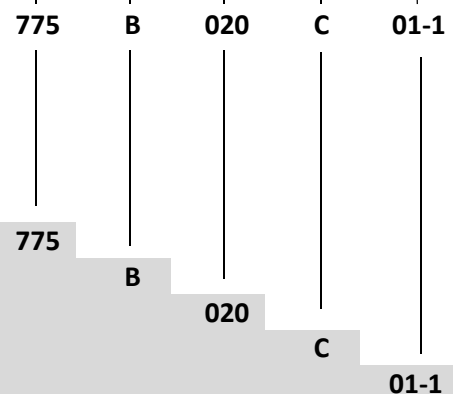

Full lift safety valve, threaded ends , angle form
 Nodular cast iron EN-GJS-400-15
 Nominal diameter (mm)
 Nominal pressure PN 16
 Basic type for liquids, vapours and gases, metal/metal sealing

Data given can be changed without notice.

Edition 01/2018